

PROGRAMMING THE TIMER #2

E. How to use OVERRIDE functions

619-programming-mode Timer is designed with 2 Override function, so as to widen its usage upon practicable application. Override function is **effective only** when Timer is running under **AUTO** mode.

Temporary-Override --- Follow procedure below:

Condition-1 When Timer's output status is "**ON**" Pressing **MANUAL** key, to move indicator from "AUTO" to "OFF", Timer output shall turn to "OFF" status, programs overridden. Pressing **MANUAL** again to switch Timer status to "AUTO", Timer's output shall continue maintaining "OFF". Timer shall resume its automatic operation when next program(event) calls for "ON". (With next opposite set point).

Condition-2 When Timer's output status is "**OFF**" Pressing **MANUAL** key, to move indicator from "AUTO" to "ON", timer output shall turn to "ON" status, programs overridden.

Pressing **MANUAL** again to switch Timer status to "AUTO", Timer's output shall continue maintaining "ON". Timer shall resume its automatic operation when next program(event) calls for "OFF". (Until next opposite set point)

Random-Start-Up Override – Press and hold **DAY** key and then press **MIN** key. There shall be a symbol **J.L.T** shows on left corner of LCD screen, to indicate this Override in executing.

When this Override is being executed, the original programs will be stopped, and once every 10 to 120 minutes Timers shall automatically turn its output to "ON" status.

In practicable application which is applied to home-use, this Override function also called Anti-Burglar Override.

Once again to press and hold **DAY** key, and then press **MIN** key shall terminate this Override.

HOW TO REPLACE BATTERIES

For Model with Lithium CR2032

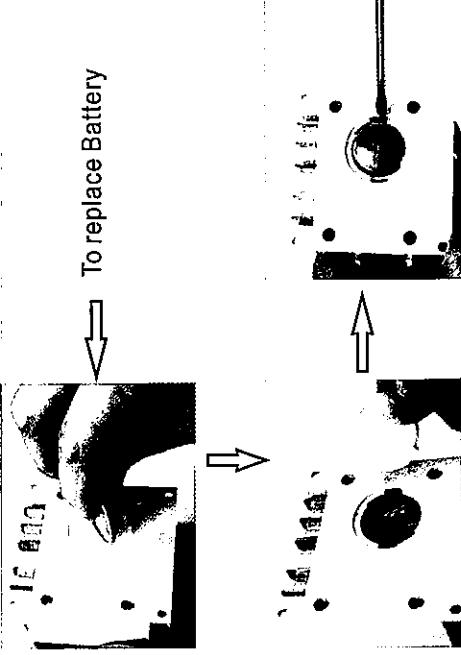

PROPOSED APPLICATION

Output terminal of Timer is produced with Flat-head Jack-Type socket to provide convenient electrical wiring upon mounting Timer on equipments.



Subject to output formats and formats of Contact Rating, there are 3 different styles in TM-619-series.

Remark:

1. For voltage and electrical **RATING** information, please refer to the markings on the back of timer.
2. See the back of timer for proper wire connections.
3. Timer may need to be connected to power source in order to set the program.

Follow graphic description below & Refer to section of **Descriptions to Model Code** on this instruction-sheet upon proceeding electrical wiring.

1.TH-619 - 1~4 Volt Free output

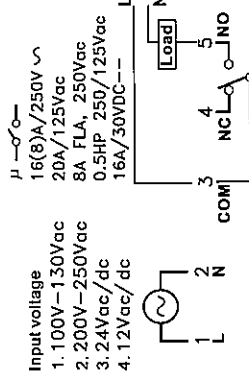

2.TH-619L - 1~4 Volt output

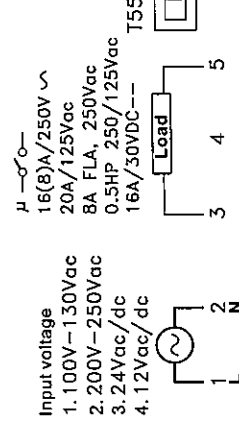

3.TH-619H - 1~4 Volt output

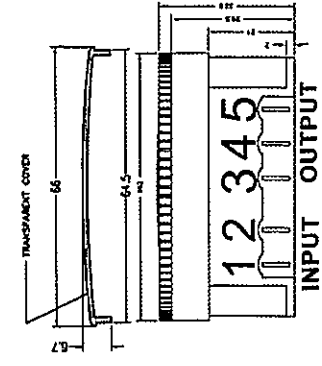
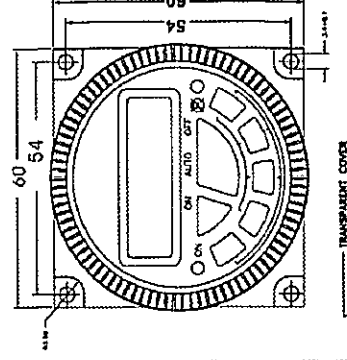
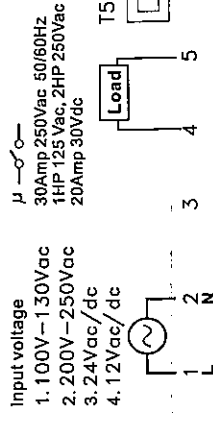

TRANSPARENT COVER

BI-61900-003B0

GENERAL INFORMATION

This Panel-Mount Digital Timer series can be operated in 4 separate power supplies, ranges from 240 Vac to 12 Vdc. Output format can be produced to be Volt-free or voltaic-output.

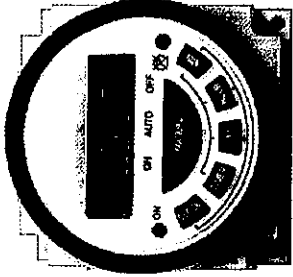

TM-619-series

Batteries of Lithium CR2032 or rechargeable V80H available for option which is for retaining the programming during Timer's operating power disconnected.

This Digital Timer is accurate to the minute, designed with either **6 or 8 ON/OFF(event) per day** Graphic description, as below:

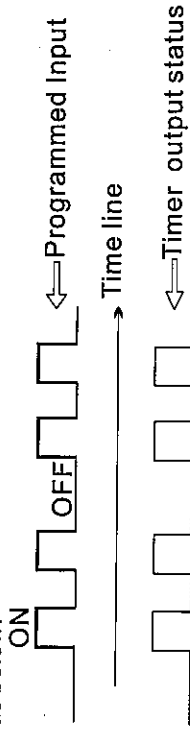

Also, it provides 15-combination of Daily-Programs which can lead great convenience to users upon choosing the required days in a week for operating the timer.

1.	MO	TU	WE	TH	FR	SA	SU
2.	MO						
3.	TU						
4.	WE						
5.	TH						
6.	FR						
7.	SA						
8.	SU						
9.	MO	TU	WE	TH	FR		
10.	SA SU						
11.	MO	TU	WE	TH	FR	SA	
12.	MO	TU	WE				
13.	TH FR SA						
14.	MO WE FR						
15.	TU TH SA						

DESCRIPTIONS TO MODEL CODE

- 12H or 24H clock format
- 2, 6 or 8 on/off per day
- Lithium CR2032 or rechargeable V80H batteries above 3 items are prefixed at production.

H : Volt-Free contact, 250Vac/16Amp Rating
 L : Volt Output, 250Vac/20Amp Rating
 L : Volt Output, 250Vac/16Amp Rating

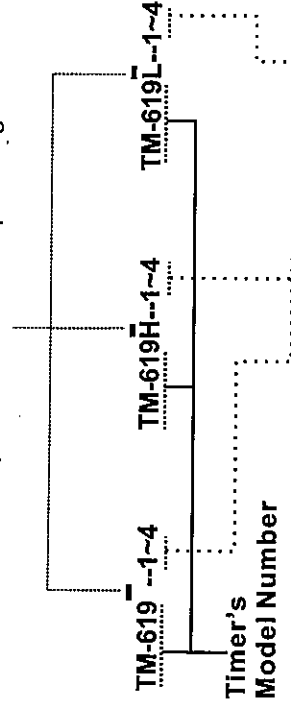

- 1 ~ 4 Power supply for Timer**
- 1: 120Vac ± 10%
 - 2: 240Vac ± 10%
 - 3: 24Vac/Vdc
 - 4: 12Vdc

PROGRAMMING THE TIMER #1

A. Functional description to buttons on panel

1. **TIMER** : Programs review & setting programs
2. **MANUAL** : To select "ON, AUTO or OFF"
3. **CLOCK** : To adjust current DAY and TIME
4. **Day** : To adjust day of week
5. **HOUR** : To adjust Hour
6. **MIN** : To adjust minute
7. **⊗** : Reset Timer's setting
8. **LED** : To indicate ON/OFF status

Press **⊗** button to reset Timer before programming

B. Adjusting CLOCK

Press and hold **CLOCK** and then press **DAY** key, **HOUR** key, **MIN** key respectively to adjust clock of Timer to accurate **DATE, HOUR, MINUTE**. In 12-Hour-Format, **PM & AM** shall appear on LCD screen. In 24-Hour-Format LCD screen shall indicate 0:00 ~23:59

C. Start to programming the TIMER

1. Press **TIMER** key. LCD screen shall show

1^{ON} _ _ : _ _ : _ _

2. Press **DAY** key to select any of 15-combination of Daily-Programs to your application demand. Continuing to press **DAY** key, LCD shall alternating indicate among 15-combinations.
3. Press **HOUR** , **MIN** respectively to set desired Hour and Minute for 1^{ON}
4. After finished setting of 1^{ON} , Press **TIMER** key again, 1^{OFF} _ _ : _ _ : _ _ shall appear on LCD screen.
5. Press **DAY** key to select any of 15-combination of Daily-Programs to your application demand. Continuing to press **DAY** key, LCD shall alternating indicate among 15-combinations.

Day-combination chosen in each of ON/OFF program-period must be consistent.

6. Repeat Programming procedure "3" to set desired Hour & Minute for 1^{OFF}

7. When finished setting 1^{ON} & 1^{OFF} , Press **TIMER**,

2^{ON} _ _ : _ _ : _ _

shall appear on LCD screen.

8. Repeat programming procedure above to complete rest of ON/OFF program-period(event)

1^{ON} _ _ : _ _ : _ _

↑ 1^{OFF} _ _ : _ _ : _ _
 or just to the desired number of ON/OFF(event) setting for demand of practicable application.

1^{ON} _ _ : _ _ : _ _

9. When finished program-setting(event), press **CLOCK** , Timer shall start to execute programs.

D. To review programs

Keep to press **TIMER** , display on LCD screen shall alternating display among each of **6 or 8 ON/OFF**