

# AP AUSPICIOUS

## CONTROL COMPONENTS



### 傳統型按鈕開關

2011 / A



**PILOT LAMP**

PLR                      25                      2                      G

| Lens type                                                             | Mounting             | Voltage rating   |                              | With Transformer<br>變壓器型 | Lens color<br>R: Red<br>G: Green<br>Y: Yellow<br>B: Blue<br>W: White | Bulb type                    |                |  |
|-----------------------------------------------------------------------|----------------------|------------------|------------------------------|--------------------------|----------------------------------------------------------------------|------------------------------|----------------|--|
| PLR: Round<br>PLS: Square<br>PLF: Flat<br>PLB: Big<br>FPL: Flush type | 22 φ<br>25 φ<br>30 φ | 1<br>2<br>3<br>4 | 110V<br>220V<br>380V<br>440V |                          |                                                                      | Without Transformer<br>無變壓器型 | 25 φ           |  |
|                                                                       |                      | 5<br>6<br>7<br>8 | 6V<br>18V<br>24V<br>30V      | E-10<br>E-10<br>E-10     | 6.3V<br>24V<br>30V                                                   |                              | 1W<br>1W<br>1W |  |
|                                                                       |                      |                  |                              | 30 φ                     |                                                                      |                              |                |  |
|                                                                       |                      |                  |                              | E-12                     | 18V<br>24V<br>30V                                                    |                              | 2W<br>2W<br>2W |  |

**DIMENSIONS**

PLT-22 22 φ 變壓器指示燈  
Transformer pilot lamp

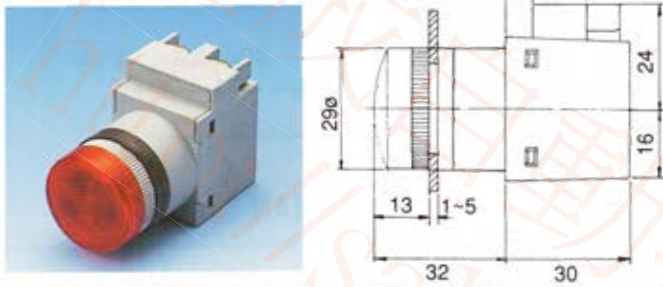

PLR-30 Round lens, PLF-30 Flat round lens  
30 φ 圓形指示燈 ; 30 φ 平圓形指示燈

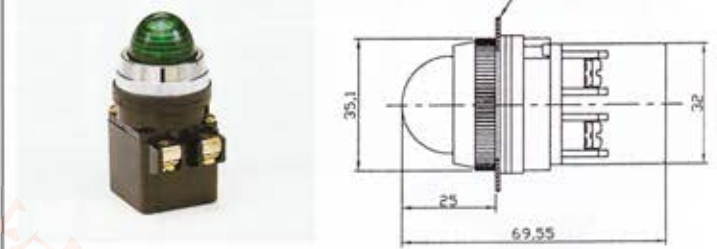

PLR-25 25 φ 圓形指示燈

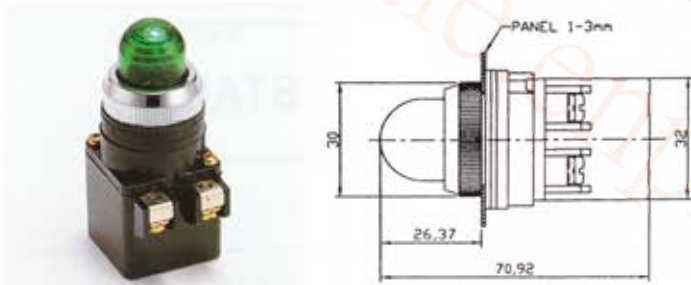

PLB-30 30 φ 特大圓形指示燈

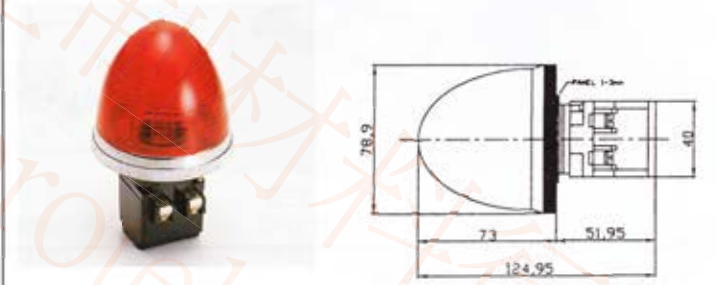

PLS-25 25mm φ, PLS-30 30mm φ  
25 φ 方框指示燈 ; 30 φ 方框指示燈

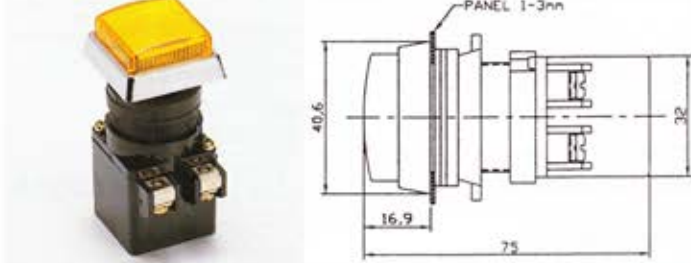

FPL-30 30 φ 閃爍型平圓指示燈

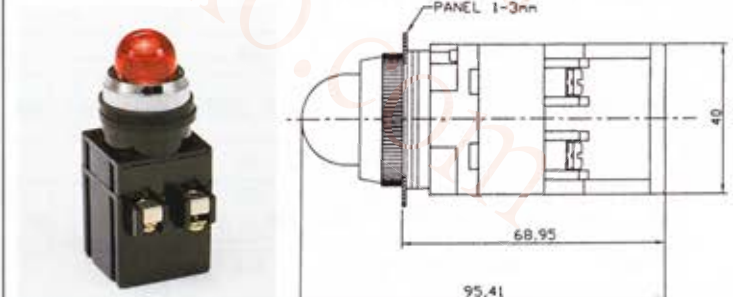

PLF-25 25 φ 平圓形指示燈

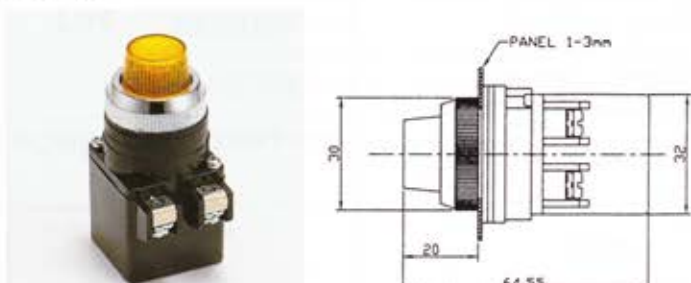

FPLB-30 30 φ 閃爍型特大圓指示燈

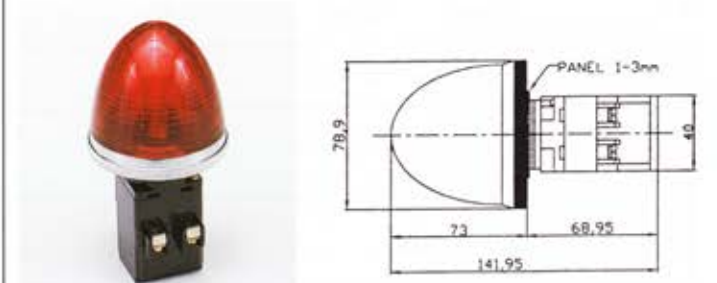

**PILOT LAMP**

L-22 22φ LED lamp 22φ LED指示燈

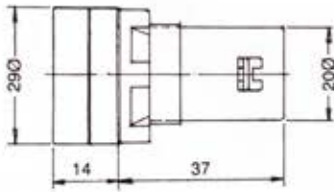

NPLRR-25A 25φ 圓形護圈指示燈

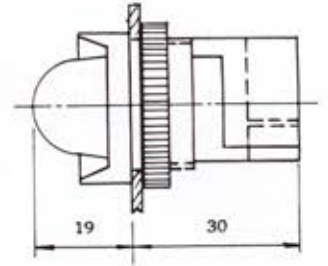

NPLR-25A 25φ 圓形指示燈

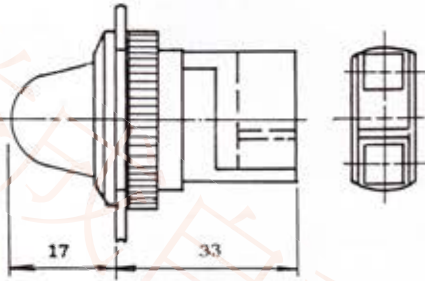

SNPLR-25 25φ 圓形指示燈

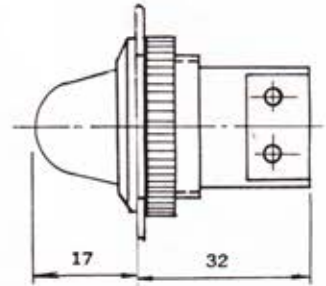

NPLF-25A 25φ 平頭型指示燈

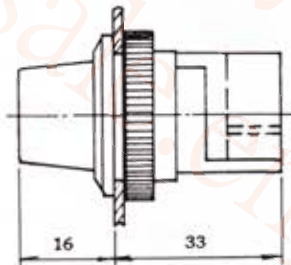

NPLR-30A 30φ 圓形指示燈

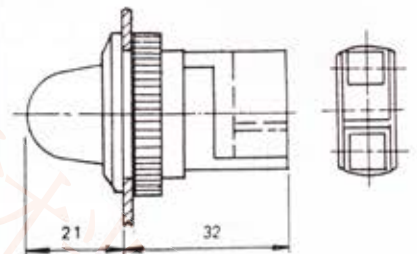

NPLR-25B 25φ 圓形指示燈

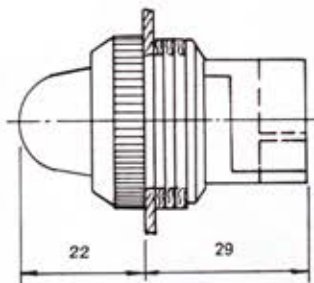

NPLF-30A 30φ 平頭型指示燈

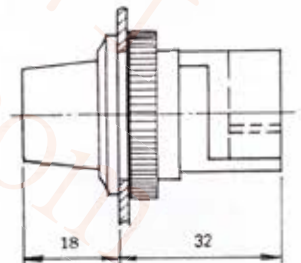

NPLF-25B 25φ 平圓形指示燈

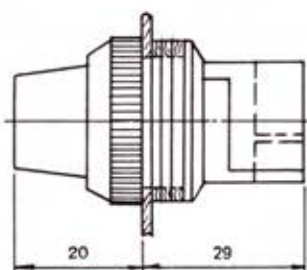

NPLS-30A 30φ 方形指示燈

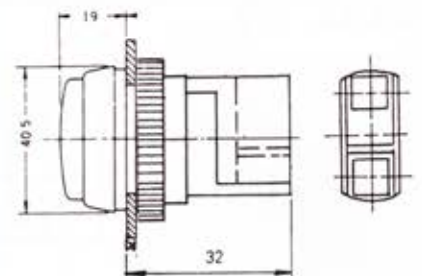

### PUSH BUTTON SWITCH

|                                                                                                                                                                                                     |                                        |                |                                |                                             |
|-----------------------------------------------------------------------------------------------------------------------------------------------------------------------------------------------------|----------------------------------------|----------------|--------------------------------|---------------------------------------------|
| PB                                                                                                                                                                                                  | 25                                     | 1              | a                              | R                                           |
| Type                                                                                                                                                                                                | Mounting hole                          | No. of contact | Type of contact blocks         | Head color                                  |
| PB: Flat head<br>PBL: Long head<br>PBR: Rain proof<br>EPB: Mushroom head<br>EPBL: Big mushroom head<br>EPBLR: Big mushroom head with guard ring<br>LEPB: Push Locked<br>PBF: Long head w/guard ring | 25: 25mm $\phi$<br><br>30: 30mm $\phi$ | 1 - 4          | a: 1a (N/O)<br><br>b: 1b (N/C) | R: Red<br>G: Green<br>Y: Yellow<br>B: Black |

#### SPECIFICATIONS

|                |               |               |               |               |                 |
|----------------|---------------|---------------|---------------|---------------|-----------------|
| AC 125V<br>10A | AC 250V<br>6A | AC 500V<br>3A | DC 125V<br>2A | DC 250V<br>1A | DC 500V<br>0.4A |
|----------------|---------------|---------------|---------------|---------------|-----------------|

PB25-1a 25  $\phi$  平頭按鈕

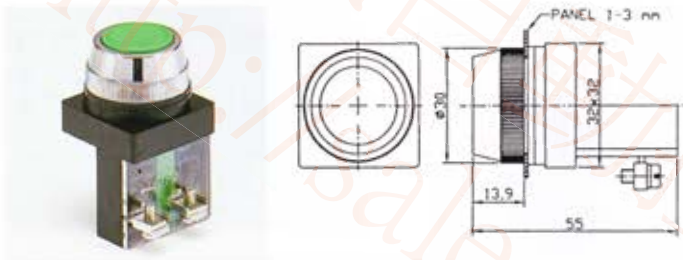

PBL25-1a 25  $\phi$  凸頭按鈕

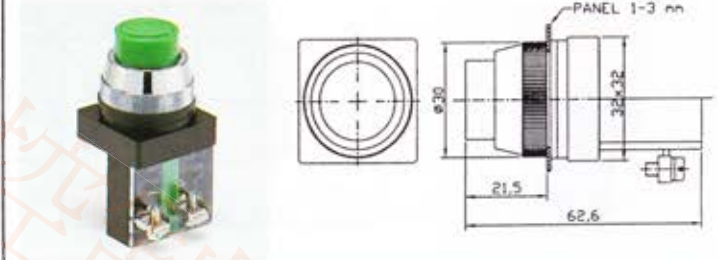

PB25-1b 25  $\phi$  平頭按鈕

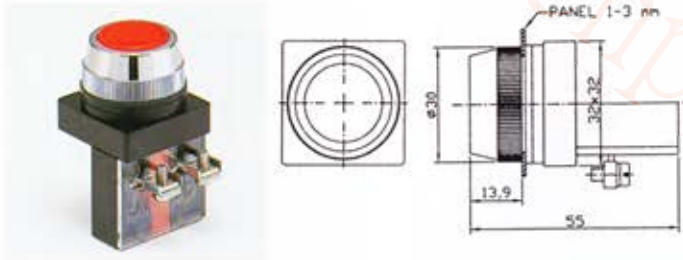

PBL25-1b 25  $\phi$  凸頭按鈕

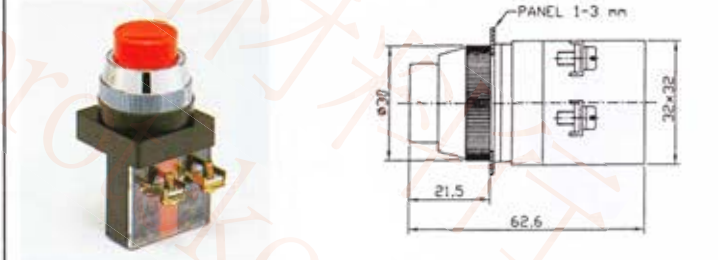

PB2511 25  $\phi$  平頭按鈕

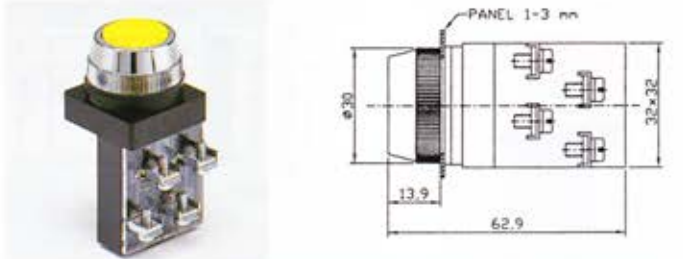

PBL25-11 25  $\phi$  凸頭按鈕

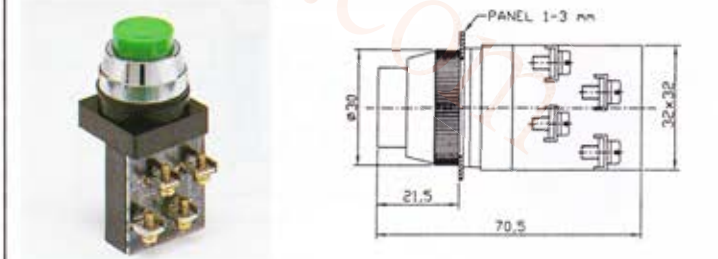

PBR2511 25  $\phi$  平頭按鈕加防水帽

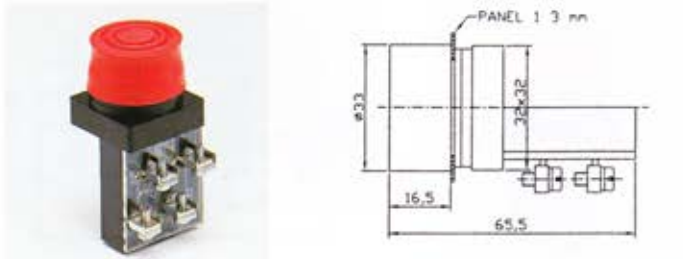

EPB25-1b 25  $\phi$  大頭按鈕

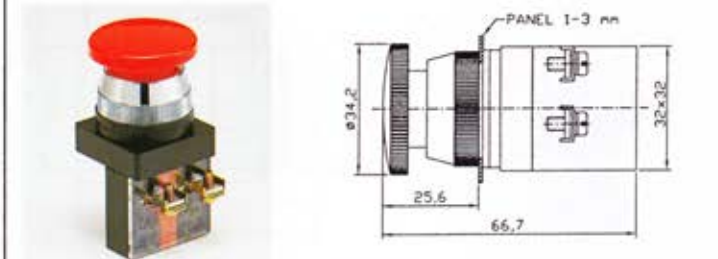

**PUSH BUTTON SWITCH**

**EPB2511 25 φ 大頭按鈕**

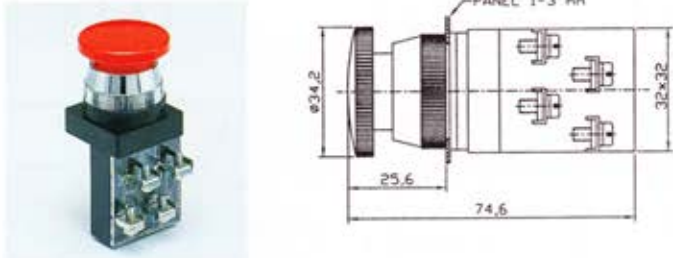

**PBL30-1a 30 φ 凸頭按鈕**

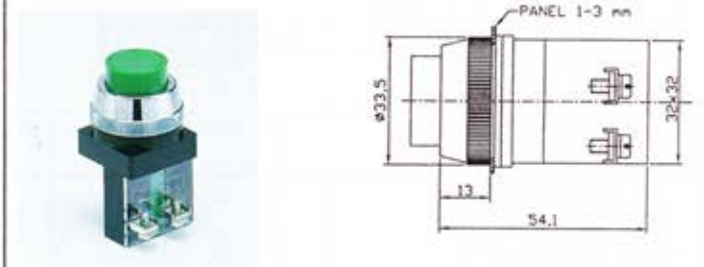

**LEPB25-1b 25 φ 急停按鈕**

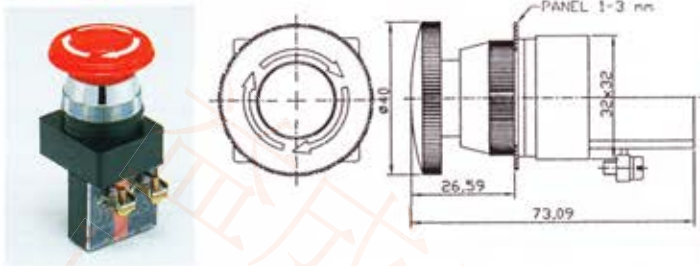

**PBL30-1b 30 φ 凸頭按鈕**

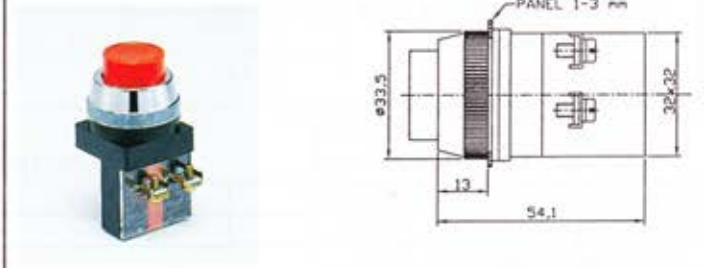

**LEPB2511 25 φ 急停按鈕**

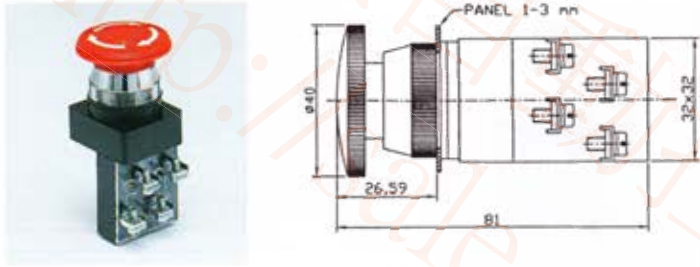

**PBL3011 30 φ 凸頭按鈕**

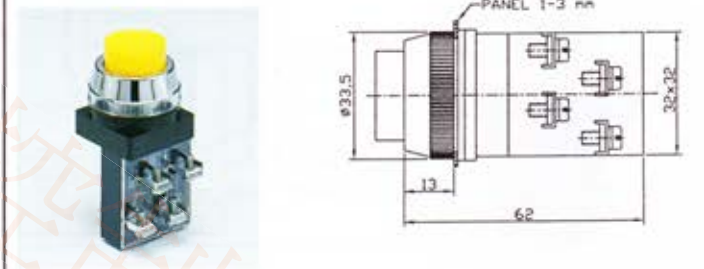

**PB30-1a 30 φ 平頭按鈕**

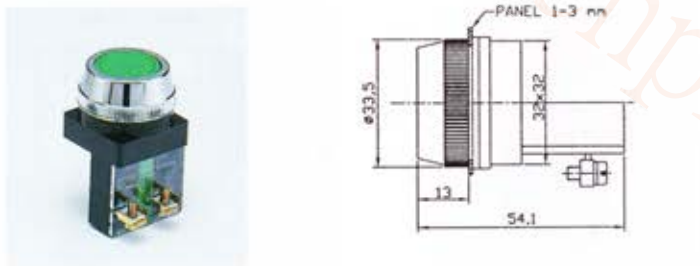

**PBR-3011 30 φ 平頭按鈕加防水帽**

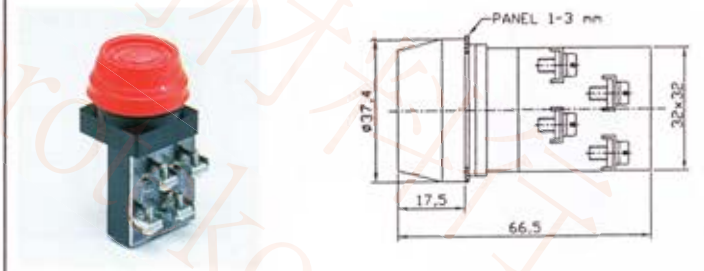

**PB30-1b 30 φ 平頭按鈕**

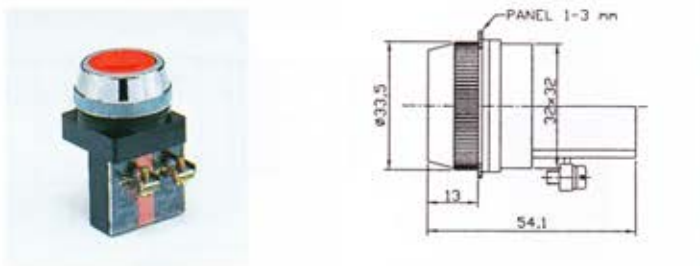

**EPB30-1b 30 φ 大頭按鈕**

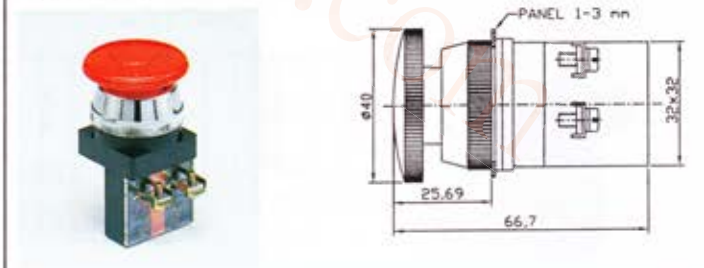

**PB3011 30 φ 平頭按鈕**

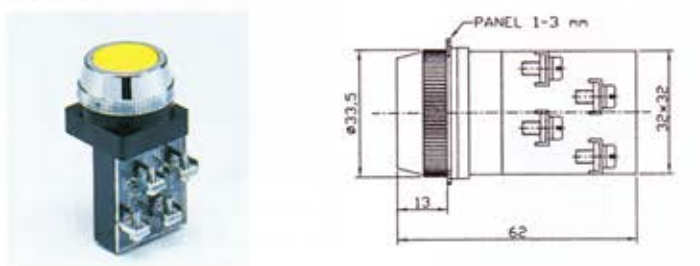

**EPB3011 30 φ 大頭按鈕**

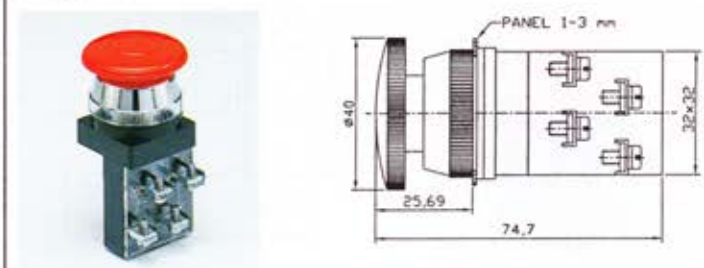

**PUSH BUTTON SWITCH**

**LEPB30-1b 30φ 急停按鈕**

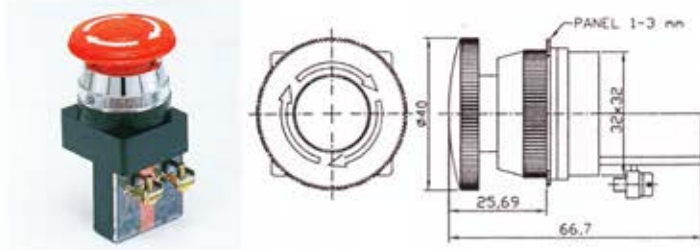

**PBK2211 22φ 平頭按鈕**

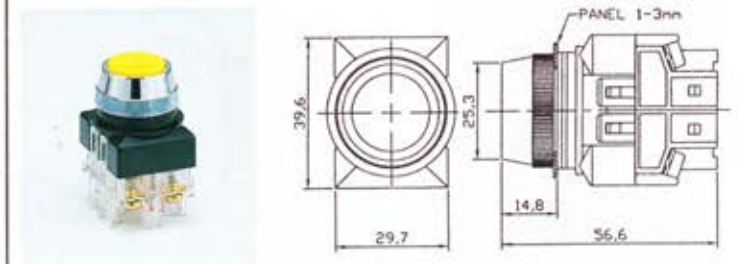

**LEPB3011 30φ 急停按鈕**

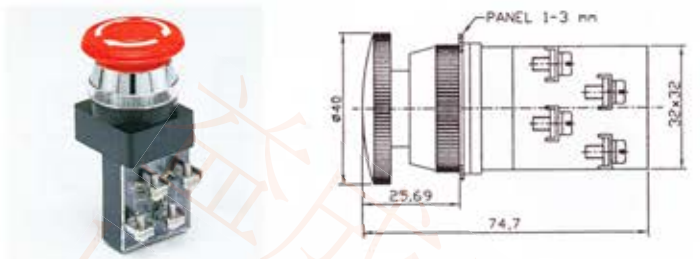

**EPBK 22-1b 22φ 大頭按鈕**

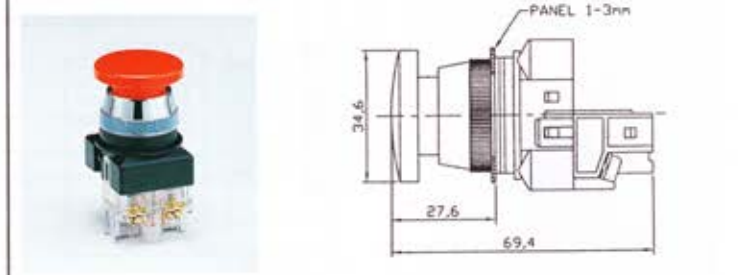

**EPBL3011 30φ 特大頭按鈕**

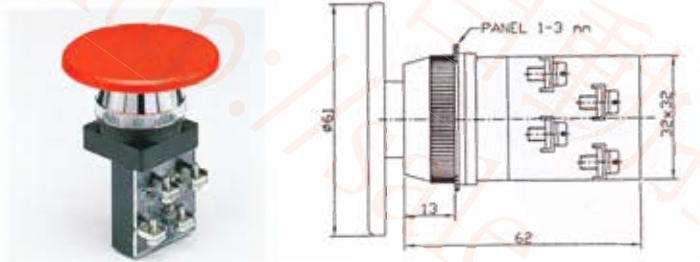

**EPBK 2211 22φ 大頭按鈕**

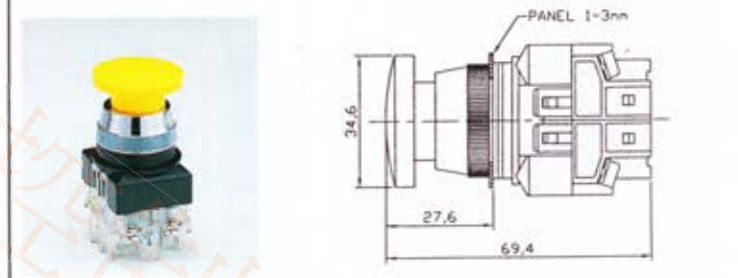

**EPBLR3011 30φ 特大頭護圈按鈕**

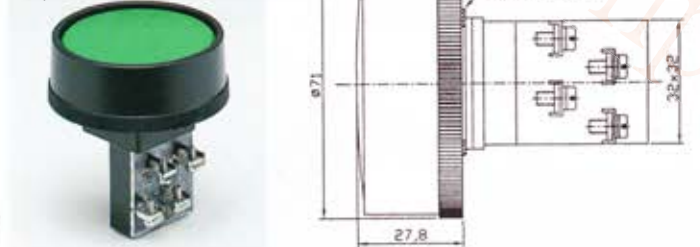

**PBK25-1a Mounting hole 25φ 平頭按鈕**

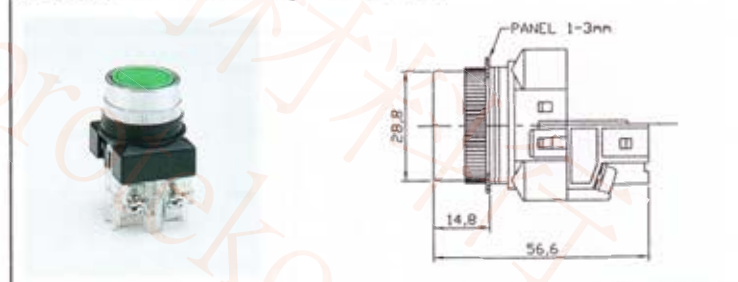

**PBK22-1a Mounting hole 22φ 平頭按鈕**

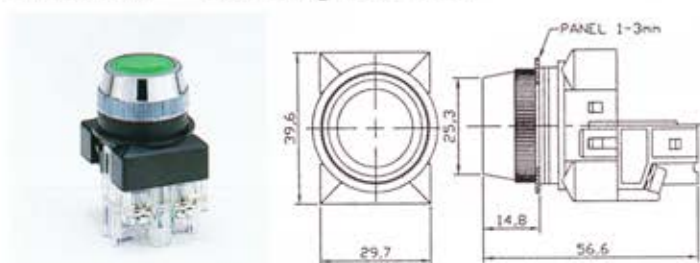

**PBK25-1b 25φ 平頭按鈕**

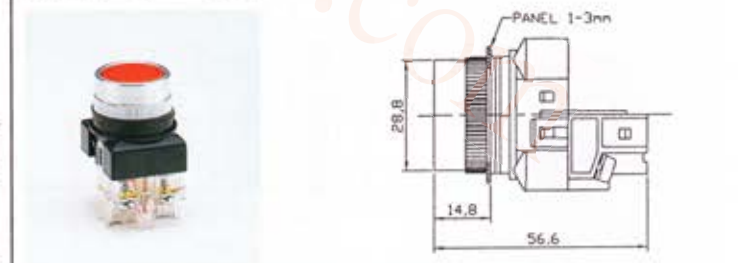

**PBK22-1b 22φ 平頭按鈕**

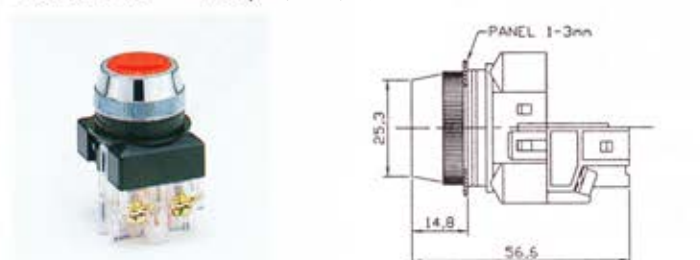

**PBK2511 25φ 平頭按鈕**

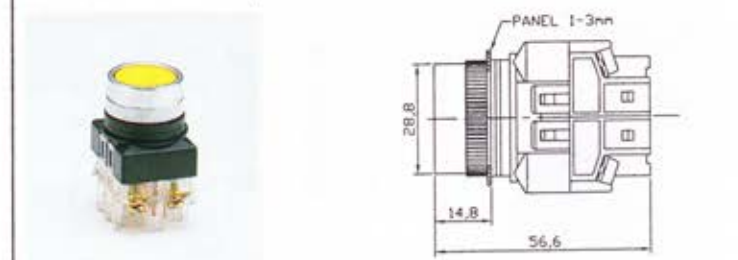

**PUSH BUTTON SWITCH**

**EPBK25-1B 25φ 大頭按鈕**

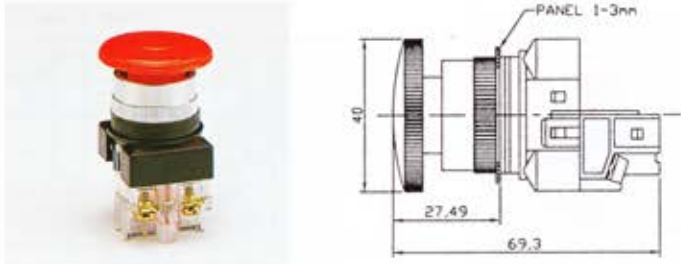

**PBK3011 30φ 平頭按鈕**

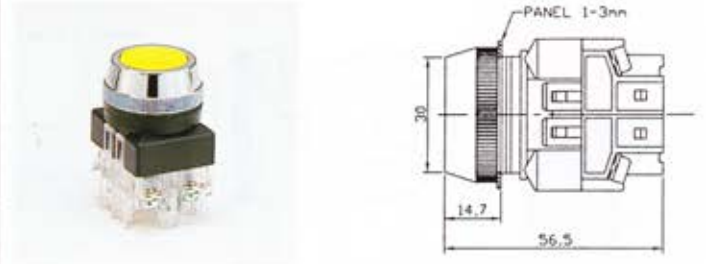

**EPBK2511 25φ 大頭按鈕**

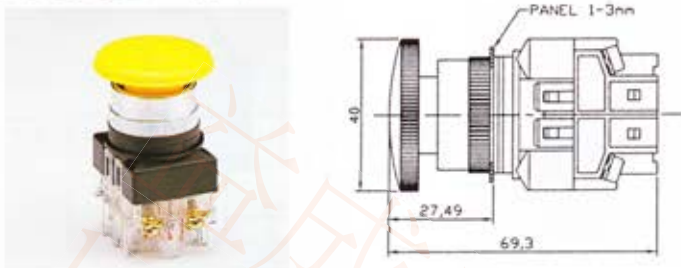

**PB22-1A(N/O), 22mm dia 22φ 簡易型按鈕**

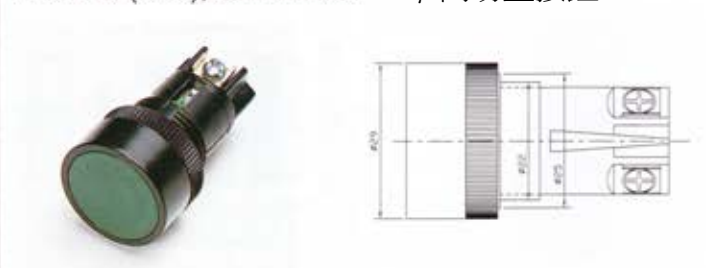

**PBK30-1a 30φ 平頭按鈕**



**PB22-1B(N/C), 22mm dia 22φ 簡易型按鈕**



**PBK30-1b 30φ 平頭按鈕**

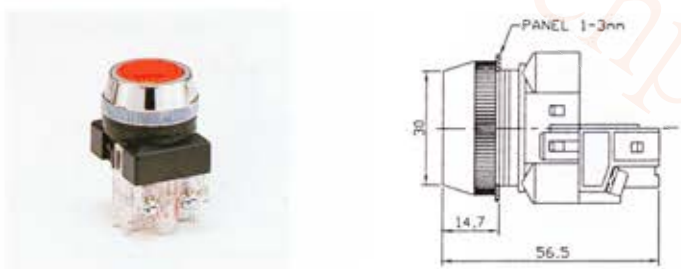

**EPBK30-1b 30φ 大頭按鈕**

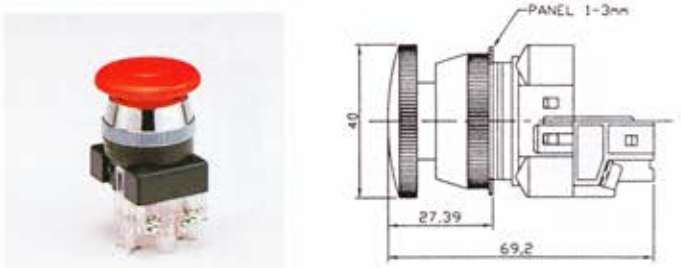

**EPBK3011 30φ 大頭按鈕**

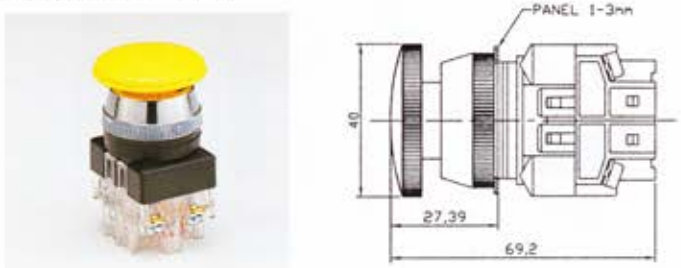

### ILLUMINATED PUSH BUTTON SWITCH

|                                                                                                    |                                        |                                             |                                                                     |
|----------------------------------------------------------------------------------------------------|----------------------------------------|---------------------------------------------|---------------------------------------------------------------------|
| LPBT                                                                                               | 25                                     | 2                                           | R                                                                   |
| Type                                                                                               | Mounting hole                          | Voltage                                     |                                                                     |
| LPBT: Standard W/TR<br>LPBTG: With Guard<br>LPBN: Standard W/Neon lamp<br>LPBNG: Neon lamp W/Guard | 25: 25mm $\phi$<br><br>30: 30mm $\phi$ | 1<br>2<br>3<br>4<br>5<br>6<br>7<br>8        | 110V<br>220V<br>380V W/TR<br>440V<br>6V<br>18V W/O TR<br>24V<br>30V |
|                                                                                                    |                                        | Lens color                                  |                                                                     |
|                                                                                                    |                                        | R: Red<br>G: Green<br>Y: Yellow<br>B: Black |                                                                     |

#### SPECIFICATIONS

|                |               |               |               |               |                 |
|----------------|---------------|---------------|---------------|---------------|-----------------|
| AC 125V<br>10A | AC 250V<br>6A | AC 500V<br>3A | DC 125V<br>2A | DC 250V<br>1A | DC 500V<br>0.4A |
|----------------|---------------|---------------|---------------|---------------|-----------------|

LPBN25-1a, LPBN25-1b 25  $\phi$  直接式照光按鈕

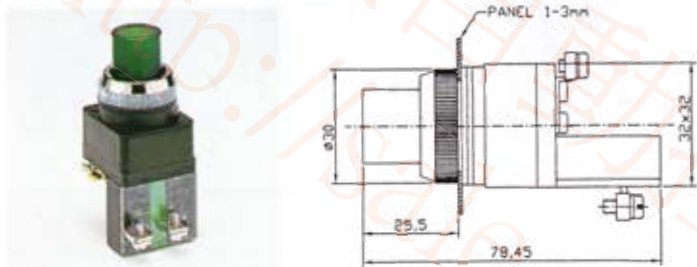

LPBN30-1a, LPBN30-1b 30  $\phi$  直接式照光按鈕

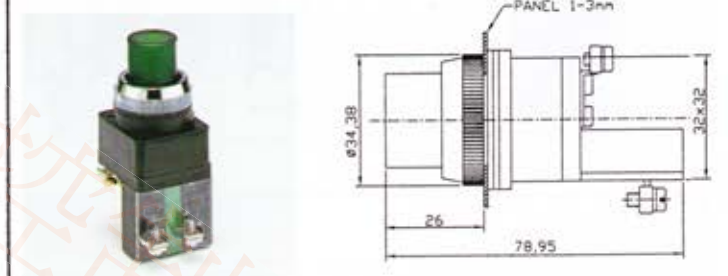

LPBN2511 25  $\phi$  直接式照光按鈕

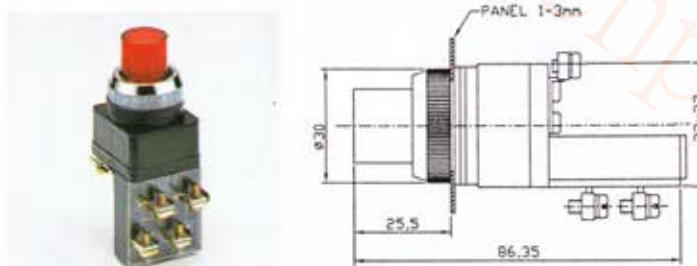

LPBN3011 30  $\phi$  直接式照光按鈕

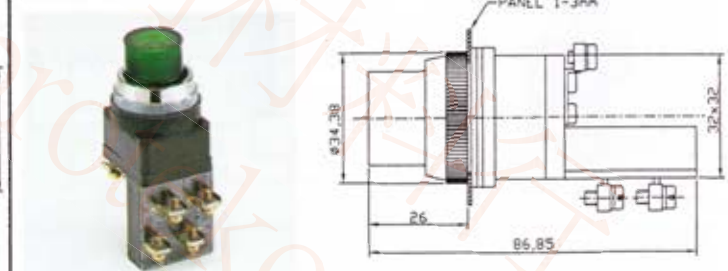

LPBT2511 25  $\phi$  變壓器式照光按鈕

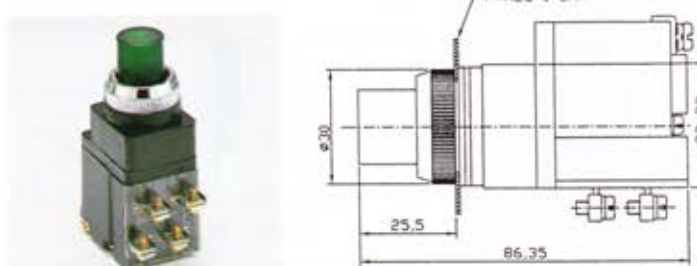

LPBT3011 30  $\phi$  變壓器式照光按鈕

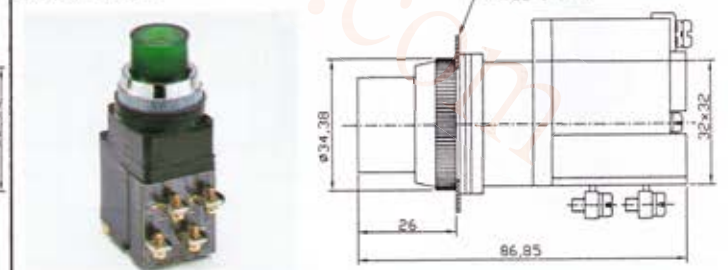

LPBTG2511 25  $\phi$  護圈照光按鈕

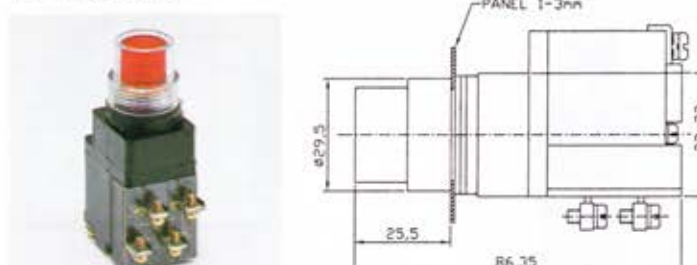

LPBTG3011 30  $\phi$  護圈照光按鈕

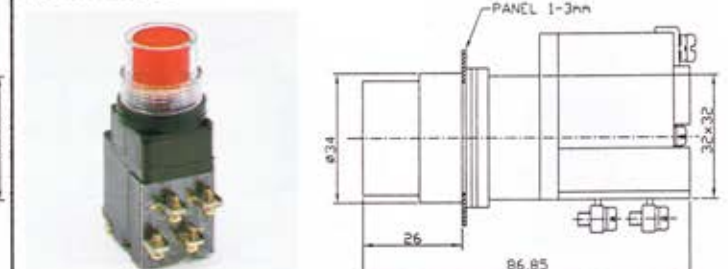

**SELECTOR SWITCH**

|                                                       |                                    |                             |                                    |                          |                                |
|-------------------------------------------------------|------------------------------------|-----------------------------|------------------------------------|--------------------------|--------------------------------|
| SS                                                    | 25                                 | 1                           | a                                  | 2                        | B                              |
| Type                                                  | Mounting hole                      | No. of contact block fitted | Type of contact block fitted       | Position                 | Knob color                     |
| SS: Knob type<br>LSS: Lever operator<br>KSS: Key type | 25: 25mm $\phi$<br>30: 30mm $\phi$ | 1 - 4                       | 1a N/O<br>1b N/C<br>1a1b (N/O+N/C) | 2 position<br>3 position | R: Red<br>G: Green<br>B: Black |

**SPECIFICATIONS**

|                |               |               |               |               |                 |
|----------------|---------------|---------------|---------------|---------------|-----------------|
| AC 125V<br>10A | AC 250V<br>6A | AC 500V<br>3A | DC 125V<br>2A | DC 250V<br>1A | DC 500V<br>0.5A |
|----------------|---------------|---------------|---------------|---------------|-----------------|

SS25-1a 25  $\phi$  短柄選擇開關

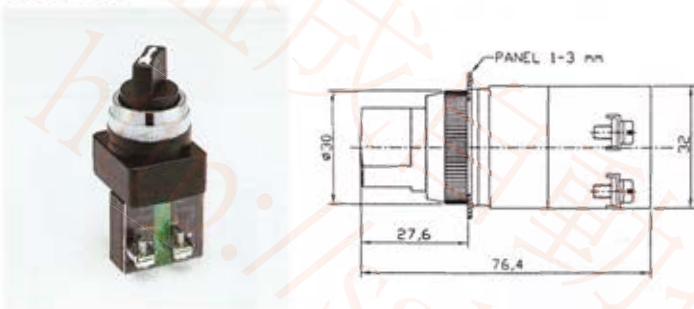

LSS2512 25  $\phi$  長柄選擇開關

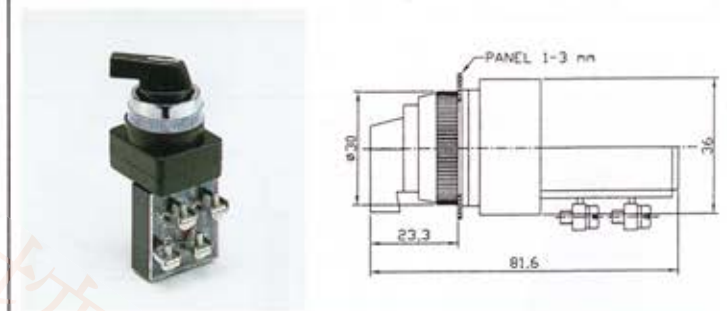

SS25-1b 25  $\phi$  短柄選擇開關

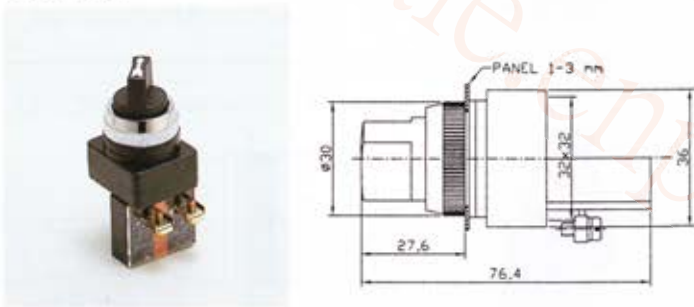

LSS2513 25  $\phi$  長柄選擇開關

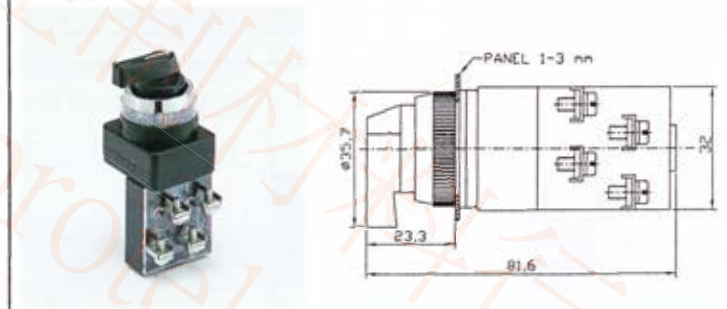

SS2512 25  $\phi$  短柄選擇開關

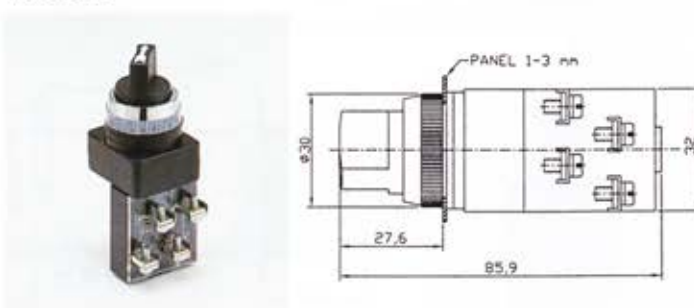

KSS25-1a 25  $\phi$  鑰匙開關

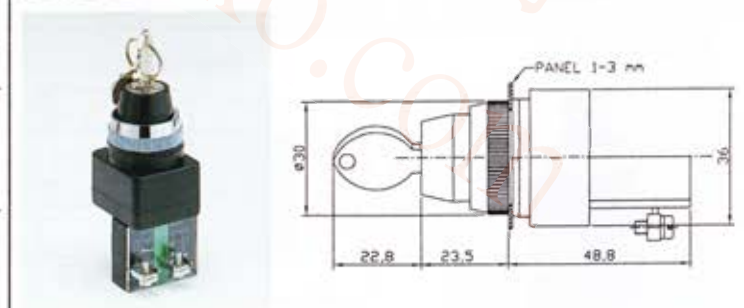

SS2513 25  $\phi$  短柄選擇開關

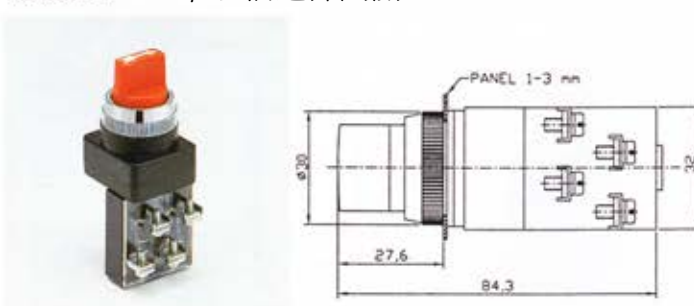

KSS2512 25  $\phi$  鑰匙開關

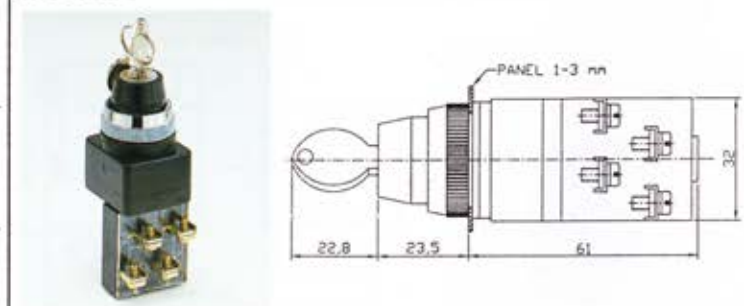

**SELECTOR SWITCH MONOLEVER SWITCH**

**KSS2513 25 φ 鑰匙開關**

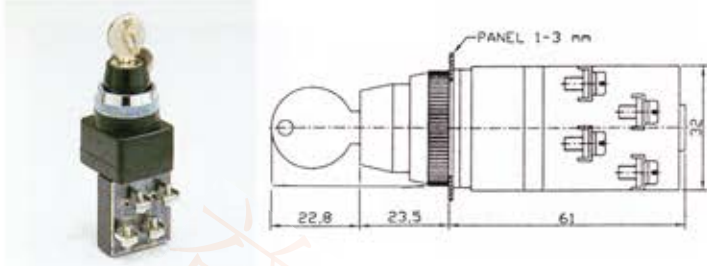

**LSS3012, 2 position 30 φ 長柄選擇開關**

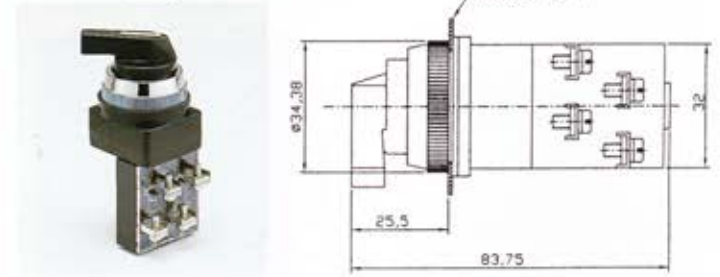

**SS30-1a 30 φ 短柄選擇開關**

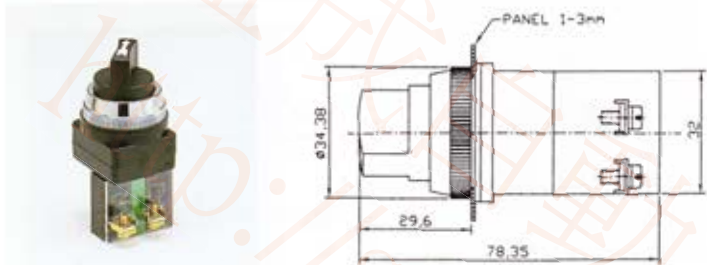

**LSS3013, 3 position 30 φ 長柄選擇開關**

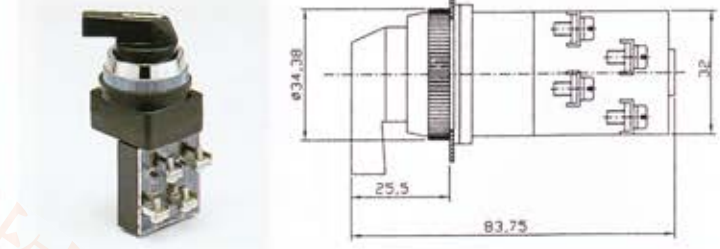

**SS30-1b 30 φ 短柄選擇開關**

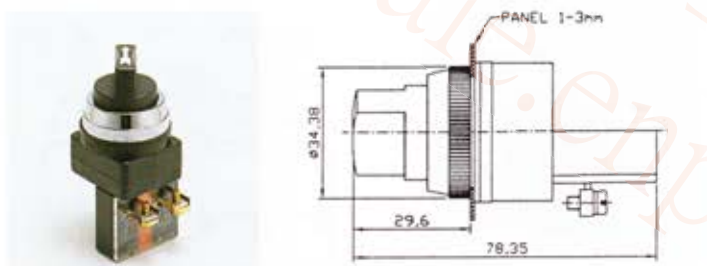

**KSS30-1a 30 φ 鑰匙開關**

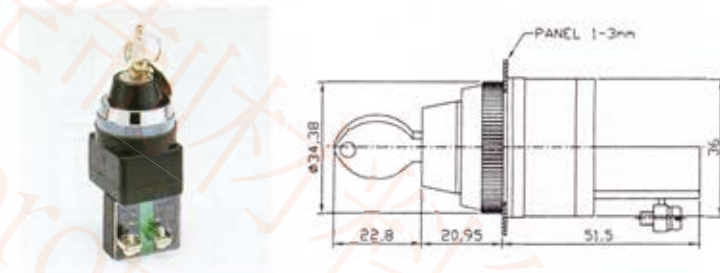

**SS3012 30 φ 短柄選擇開關**

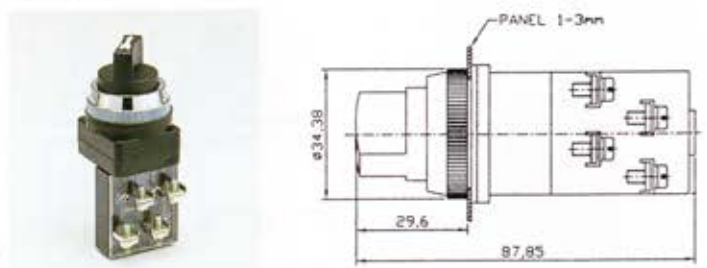

**KSS3012 30 φ 鑰匙開關**

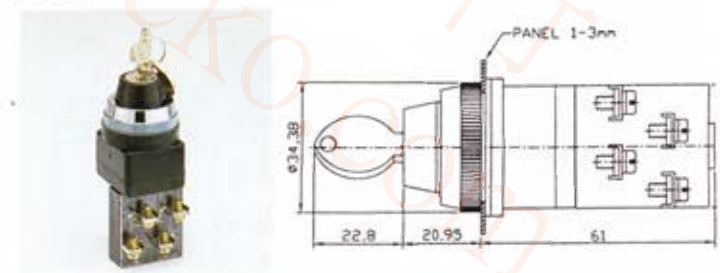

**SS3013 30 φ 短柄選擇開關**

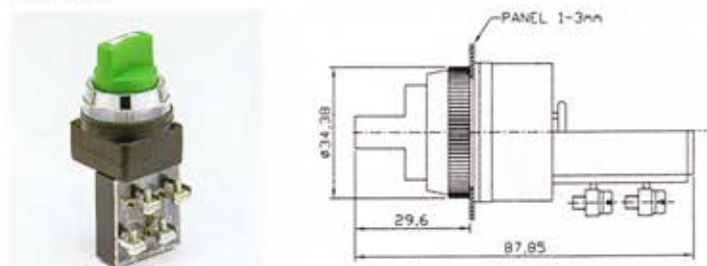

**KSS3013 30 φ 鑰匙開關**

